

Charleston Manufacturing, LLC

122 Albert Buckley Drive

Charleston MS 38921

ph. 800.647.2384

fx. 800.413.0454

www.charlestonmanufacturingllc.com

PH: 1-800-647-2384 Fax: 1-800-413-0454

Standard Extrusion/Component Catalog

Charleston Manufacturing, LLC

PH: 1-800-647-2384 Fax: 1-800-413-0454

Standard Extrusion / Component Catalog

General Information:

- All mill finish aluminum extrusions will be shipped with no prior surface preparation & are not ready for paint. Surface scratches, die marks and other imperfections will be present.
- Charleston Manufacturing, LLC extrusions are designed to be assembled with mechanical fasteners, chemically bonded with adhesive (Lords 406/10 acrylic adhesive recommended) or as a welded assembly.
- General assembly drawings for all of our standard systems are available upon request.
- There will be a minimum saw charge of \$50.00 for orders cut to length. This charge may increase due to number of cuts required.
- Due to the volatile nature of the raw aluminum market, Charleston Manufacturing, LLC reserves the right to modify these published prices without notice.

Shipping:

- Mill finish orders are typically shipped within (5) business days of receipt and acceptance of written purchase order from customer.
- Freight shall be collect, F.O.B. Charleston, MS for all orders. The customer has the option of choosing the freight carrier of preference. If no freight carrier is preferred, one will be selected by Charleston Manufacturing, LLC based upon a combination of factors including, but not limited to, freight costs & transit times.
- All freight claims for freight collect shipments are the sole responsibility of the customer.
- Any requests for expedited shipping service or any other special consideration shall be at the sole expense of the customer.
- In the unlikely event that a product is back ordered, the back order will be shipped under the terms of the original order. Additional items may be added to any back order with the additional freight expense being the sole responsibility of the customer.

Returns Policy:

- Returns of orders will not be accepted without prior written authorization from Charleston Manufacturing, LLC.
- All goods to be returned must be acknowledged in writing by the customer within (60) days of order ship date. Any claims made after this grace period will be considered invalid.
- Materials may not be returned for any reason other than **defective product** or **incorrect fulfillment of the order** by Charleston Manufacturing, LLC.
- **Incorrect fulfillment of the order** - All returned good must be in new & salable condition for full credit to be issued. Once the returned items have been received and inspected by Charleston Manufacturing, LLC, credit will be limited to and issued for the original invoiced amount. Charleston Manufacturing, LLC will arrange for pick-up and return shipment of product at no expense to the customer.
- **Defective product** - Once the returned items have been received and inspected by Charleston Manufacturing, LLC, credit will be limited to and issued for the original invoiced amount. Return freight charges are the sole responsibility of the customer. If the product is determined to be defective by Charleston Manufacturing, LLC, a copy of the original freight bill must be submitted within (60) days of receipt of the returned items to receive credit for return freight costs. Return freight charge credit or reimbursement will be limited to the amount of the freight invoice only.

CATALOG INDEX

p.01.....Series 218 / 225 / 250

p.02.....Series 325

p.03.....Series 750 / 1200

p.04.....Series 3000 / 4000 / Changeable Word Bar

p.05.....Changeable Word Bar / Miscellaneous Extrusions & Components

p.06.....Miscellaneous Extrusions & Components

p.07-10.....Pricing

Charleston Manufacturing, LLC

PH: 1-800-647-2384 Fax: 1-800-413-0454

Series 218 - Post Options

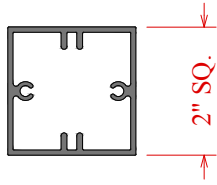

218-2 Sq. Post
C7F0288

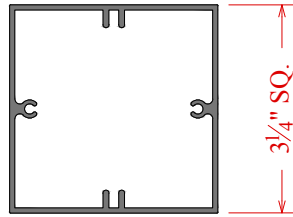

218-3 Sq. Post
C7F7288

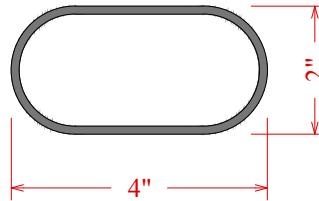

2x4 Oval Post
C51580288

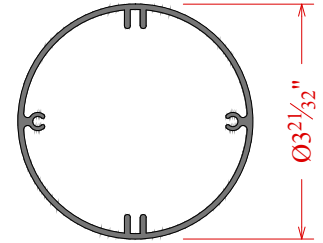

218-3 Rd. Post
C7F5288

Series 225 - Post Options

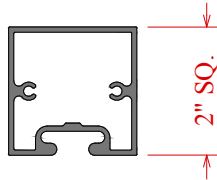

225 Std. Post
C7G0288

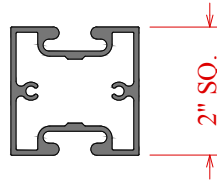

225 Dbl. Slot Post
C7G8288

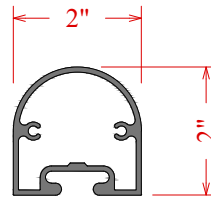

225 Ext. Rad. Post
C7G4288

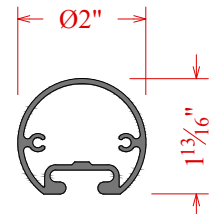

225 Full Rd. Post
C7G5288

Series 225 - Frame Options

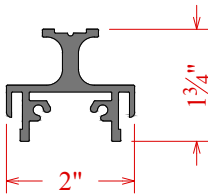

225 Std Side Frame
C6G00153

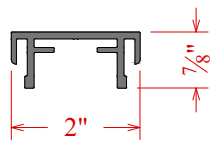

225 Std T/B Frame
C6G01153

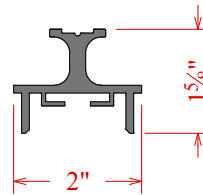

225 FF Side Frame
C6G10153

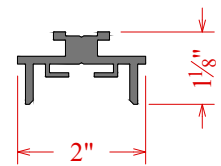

225 FF NR Side Frame
C6G12153



225 FF T/B Frame
C6G11153

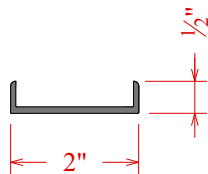

225 Radius Channel
C6G04153

Series 250 - Frame Options

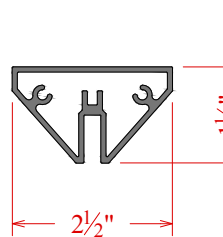

250 Std. Frame/Econo Post
C7J1192

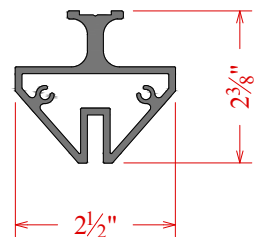

250 Side Frame
C6H00153

Series 325 Components

Post Options

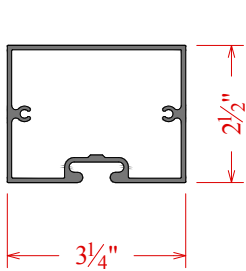

325 Std. Post
C7K0288

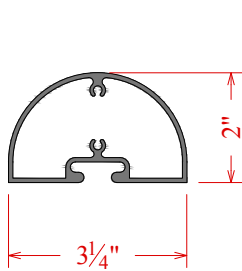

325 Rad. Post
C7K2288

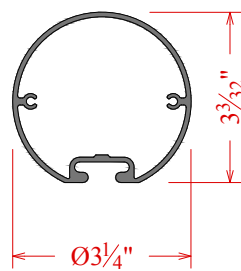

325 Full Rd. Post
C7K5288

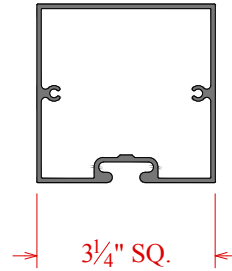

325 Sq. Post
C7K92288

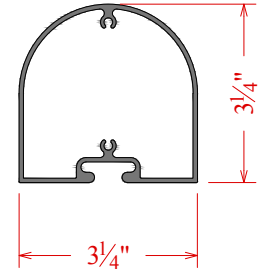

325 Ext. Rad. Post
C7K4288

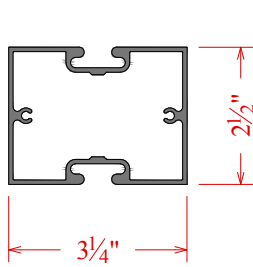

325 Dbl. Slot Post
C7K8288

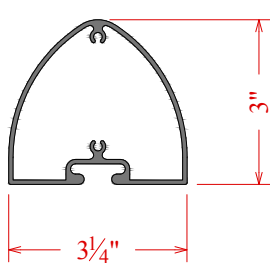

325 Contour Post
C7I9240

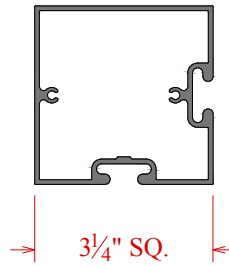

325/4000 Corner Post
C7K6288

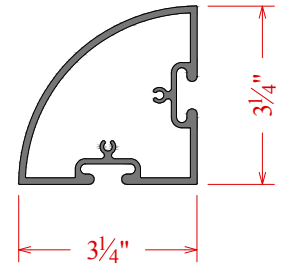

325/4000 Rad. Corner Post
C7K3288

Frame Options

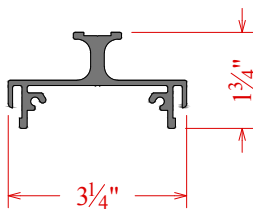

325 Std. Side Frame
C6K00153

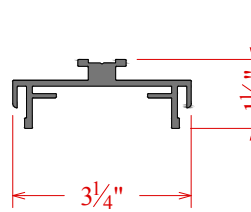

325 Std. No Reveal
Side Frame
C6K02153

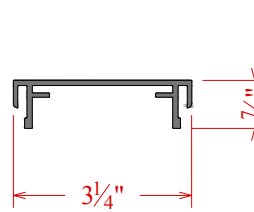

325 Std. T/B Frame
C6K01153

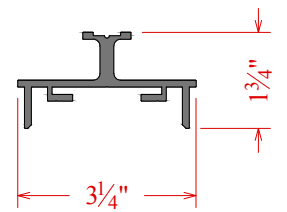

325 Flush Face
Side Frame
C6K10153

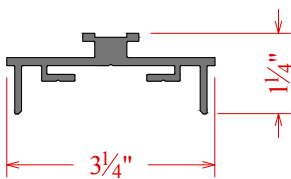

325 Flush Face
No Reveal Side Frame
C6K12153

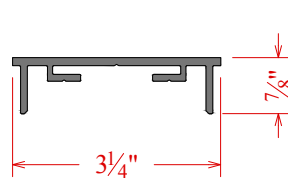

325 Flush Face
T/B Frame
C6K11153

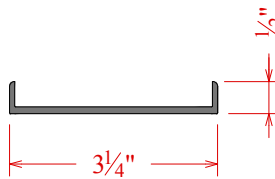

325 Radius Channel
C6K04153

Charleston Manufacturing, LLC

PH: 1-800-647-2384 Fax: 1-800-413-0454

Series 750 Components

Post Options

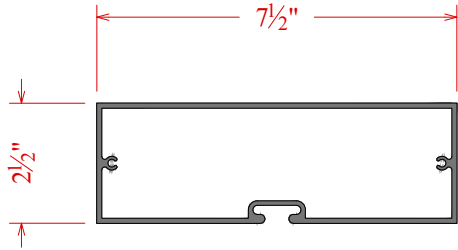

750 Std. Post
C7L0288

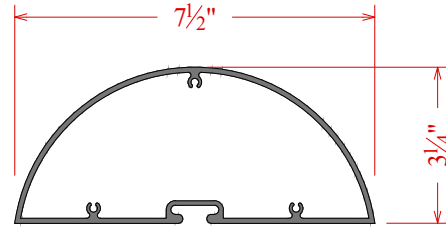

750 Rad. Post
C7L2288

Frame Options

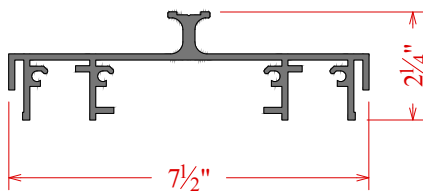

750 Std. Side Frame
C6L00153

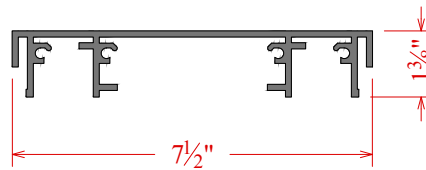

750 Std. T/B Frame
C6L01219

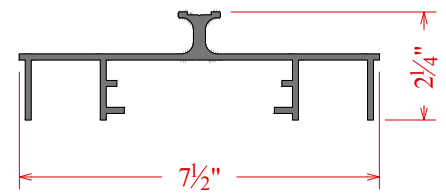

750 Flush Face Side Frame
C6L10153

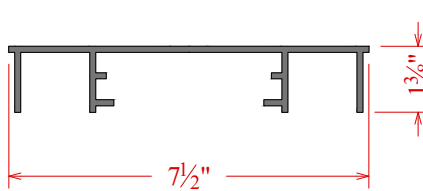

750 Flush Face T/B Frame
C6L11219

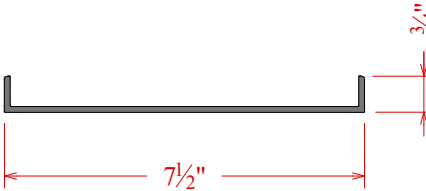

750 Radius Channel
C6L04219

Series 1200 Components

Frame Options

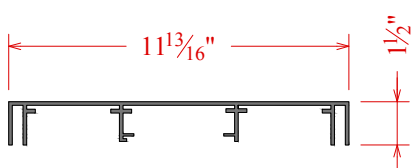

1200 Econo Frame
C6M50218

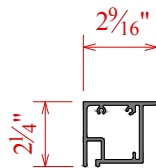

1200 Std Retainer
C6M53219
(Order w/ C6M51219)

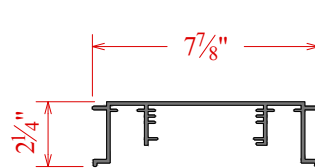

1200 Base Frame
C6M51219
(Order w/ C6M53219)

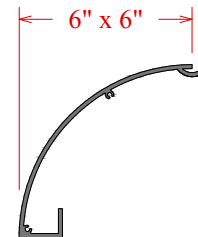

1200 Rad. End
MALE
C7N2192
(Order w/ C7N3192)

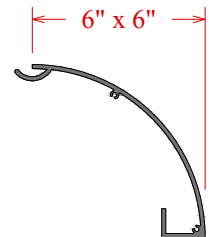

1200 Rad. End
FEMALE
C7N3192
(Order w/ C7N2192)

Charleston Manufacturing, LLC

PH: 1-800-647-2384 Fax: 1-800-413-0454

Series 3000-4000 Components

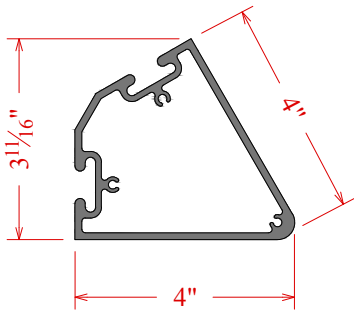

3000 Triangular Post
C7P0240

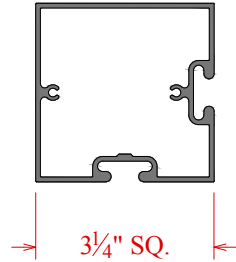

325/4000 Corner Post
C7K6288

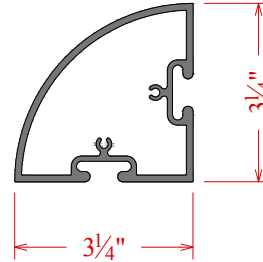

325/4000 Rad. Corner Post
C7K3288

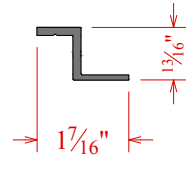

Z-Bar
C51510240

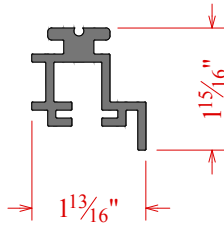

3000 Side Frame
C6P30240

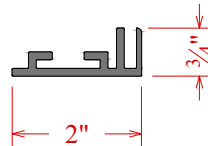

3000 T/B Frame
C6P31240

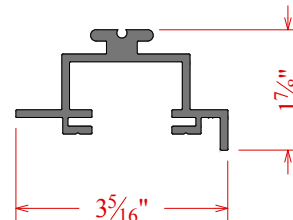

4000 Side Frame
C6Q40146

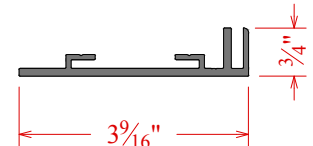

4000 T/B Frame
C6Q41240

Changeable Word Bar Components

Word Bar Extrusions

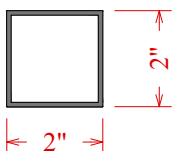

CWB2
C51192020253

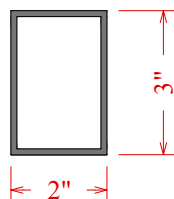

CWB3
C51142030252

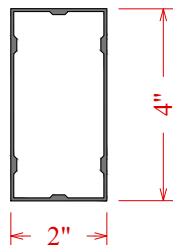

CWB4
C51142040252

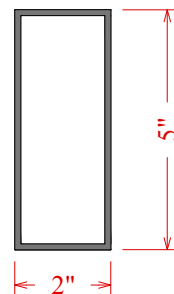

CWB5
C51142045253

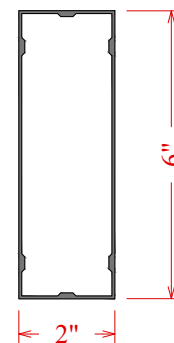

CWB6
C51142046288

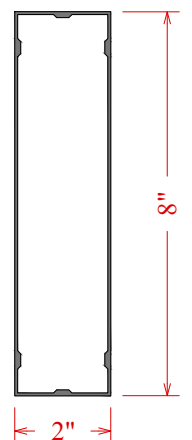

CWB8
C51142080288

Charleston Manufacturing, LLC

PH: 1-800-647-2384 Fax: 1-800-413-0454

Changeable Word Bar Components

CWB Dovetail Assembly Parts

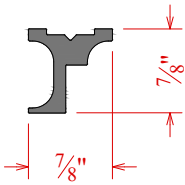

Dovetail Top
C51541153
(Order w/ C51542153
or C51545153)

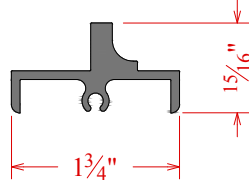

**Dovetail Bottom
w/ Screw Boss**
C51545153
(For Use in 8" or smaller CWBs,
Order w/ C51541153)

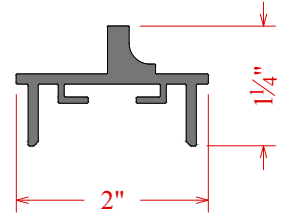

**Dovetail Bottom
w/ Corner Key Slot**
C51542153
(For Use CWBs over 8",
Order w/ C51541153)

Miscellaneous Extrusions & Components

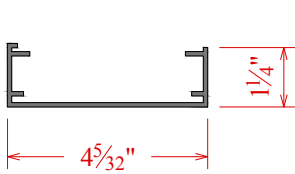

Univ. Raceway
C51570146

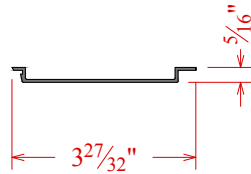

Univ. Raceway Cover
C51571219

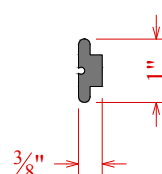

Stop Block/Post Filler
C51523153

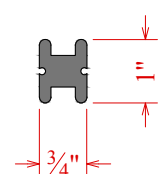

Post Connector
C51521153

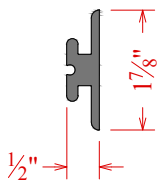

Center Mount Bracket
C51522146

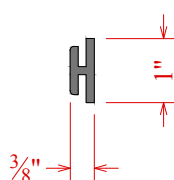

1/8" H-Bar
C51535153

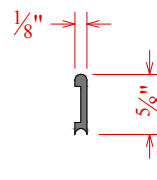

5/8" Graphic Bar
C51550050

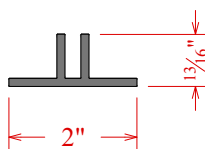

1/4" T-Bracket
C51531146

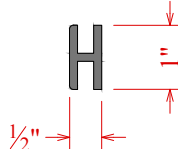

1/4" H-Bar
C51536153

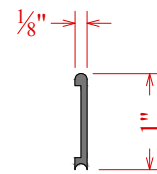

1" Graphic Bar
C51551146

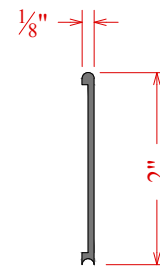

2" Graphic Bar
C51552146

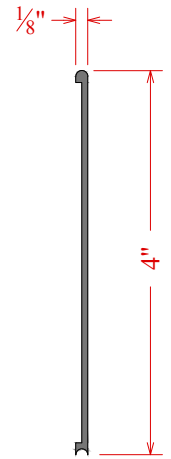

4" Graphic Bar
C51554146

Charleston Manufacturing, LLC

PH: 1-800-647-2384 Fax: 1-800-413-0454

Miscellaneous Extrusions & Components

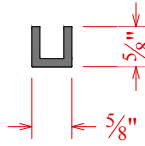

5/8" U-Channel
C51560192

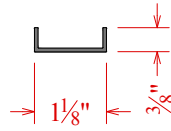

#125 U-Channel
C51561146

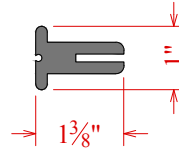

Univ. Flg. Panel Adapter
C51515146

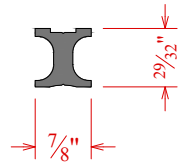

Univ. Dovetail
C51544146

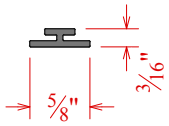

1/16" T-Divider
C51529073

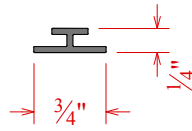

1/8" T-Divider
C51533073

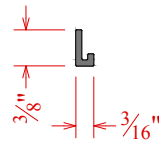

1/16" J-Mullion
C51537073

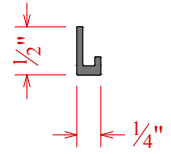

1/8" J-Mullion
C51538073

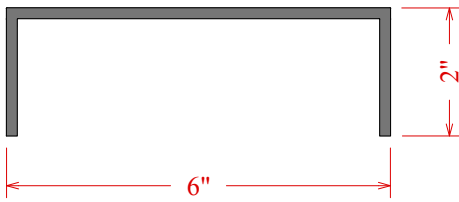

Base Mount Channel, Top
C51575218

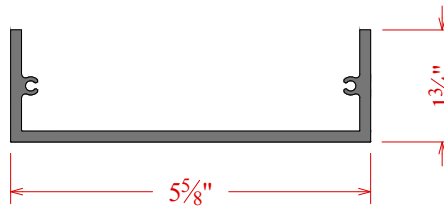

Base Mount Channel, Bottom
C51576218

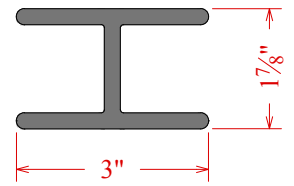

325/750 Post Support
C51525288

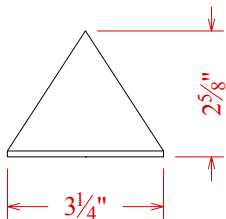

3/4" Pyramid Finial
C58513

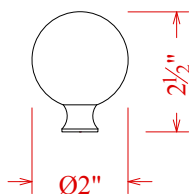

Ø2" Round Finial
C58511

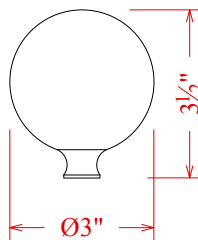

Ø3" Round Finial
C58512

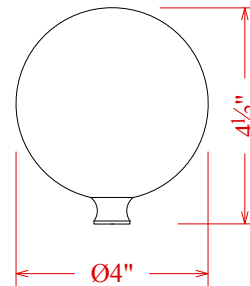

Ø4" Round Finial
C58514

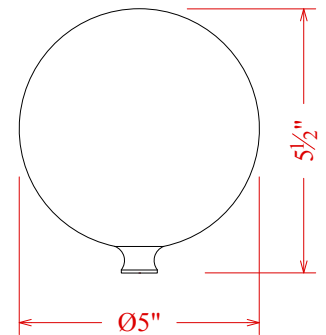

Ø5" Round Finial
C58515

Charleston Manufacturing, LLC

PH: 1-800-647-2384 Fax: 1-800-413-0454

Series 218 / 225 / 250 Components

ref. page 01

Description	P/N	Stock Length	>\$3000	<\$3000
218-2 Square Post	C7F0288	288"	\$138.00	\$156.00
218-3 Square Post	C7F7288	288"	\$139.00	\$157.00
4" Oval Post	C51580288	288"	\$150.00	\$169.00
218-3 Round Post	C7F5288	288"	\$127.00	\$143.00
225 Square Post	C7G0288	288"	\$97.00	\$110.00
225 Double Slot Post	C7G8288	288"	\$118.00	\$130.00
225 Extended Radius Post	C7G4288	288"	\$82.00	\$93.00
225 Full Round Post	C7G5288	288"	\$94.00	\$106.00
225 Standard Side Frame w/ Reveal	C6G00153	153"	\$48.00	\$53.00
225 Standard T/B Frame	C6G01153	153"	\$36.00	\$40.00
225 Flush Face Side Frame w/ Reveal	C6G10153	153"	\$44.00	\$49.00
225 Flush Face No Reveal Side Frame	C6G12153	153"	\$37.00	\$41.00
225 Flush Face T/B Frame	C6G11153	153"	\$32.00	\$36.00
225 Radius Channel	C6G04153	153"	\$16.00	\$18.00
250 Standard Frame/Econo Post	C7J1192	192"	\$109.00	\$124.00
250 Side Frame	C6H00153	153"	\$127.00	\$143.00
218-2 Square Post Cap w/ Screws				
225 Square Post Cap w/ Screws	C7G0C	--	\$3.00	\$3.00
225 Double Slot Post Cap w/ Screws				
218-3 Square Post Cap w/ Screws	C7F7C	--	\$3.00	\$3.00
218-3 Round Post Cap w/ Screws	C7F5C	--	\$3.00	\$3.00
225 Extended Radius Post Cap w/ Screws	C7G4C	--	\$3.00	\$3.00
225 Round Post Cap w/ Screws	C7G5C	--	\$3.00	\$3.00
250 Econo Post Cap w/ Screws	C7J1C	--	\$3.00	\$3.00
225 Corner Key, Standard	C583G1	--	\$1.50	\$1.50
225 Corner Key, Flush Face	C583G2	--	\$1.50	\$1.50
250 Corner Key	C583H1	--	\$1.50	\$1.50
Stop Block w/ Screws	C51523004	4"	\$3.50	\$3.50
#10-24 x 3/4" FH Phillips SS Screw	C5816402	per 100	\$19.00	\$19.00
#10-24 x 1/2" FH Phillips SS Screw	C5816403	per 100	\$18.00	\$18.00
Roll Pins, Ø $\frac{1}{8}$ " x $\frac{1}{2}$ "L	C58511505	each	\$1.00	\$1.00

Series 325 Components

ref. page 02

Description	P/N	Stock Length	>\$3000	<\$3000
325 Standard Post	C7K0288	288"	\$138.00	\$156.00
325 Double Slot Post	C7K8288	288"	\$159.00	\$179.00
325 Square Post	C7K92288	288"	\$147.00	\$162.00
325/4000 Square Corner Post	C7K6288	288"	\$216.00	\$244.00
325 Full Round Post	C7K5288	288"	\$136.00	\$153.00
325 Radius Post	C7K2288	288"	\$109.00	\$122.00
325 Extended Radius Post	C7K4288	288"	\$154.00	\$173.00
325/4000 Radius Corner Post	C7K3288	288"	\$239.00	\$268.00

Charleston Manufacturing, LLC

PH: 1-800-647-2384 Fax: 1-800-413-0454

Series 325 Components

ref. page 02

Description	P/N	Stock Length	>\$3000	<\$3000
325 Contour Post	C7I9288	288"	\$104.00	\$119.00
325 Standard Side Frame	C6K00153	153"	\$68.00	\$75.00
325 Standard No Reveal Side Frame	C6K02153	153"	\$51.00	\$57.00
325 Standard T/B Frame	C6K01153	153"	\$37.00	\$41.00
325 Flush Face Side Frame	C6K10153	153"	\$61.00	\$68.00
325 Flush Face No Reveal Side Frame	C6K12153	153"	\$57.00	\$64.00
325 Flush Face T/B Frame	C6K11153	153"	\$42.00	\$48.00
325 Radius Channel	C6K04153	153"	\$23.00	\$26.00
325 Standard Post Cap w/ Screws	C7K0C	--	\$3.00	\$3.00
325 Double Slot Post Cap w/ Screws	C7F7C	--	\$3.00	\$3.00
325/4000 Corner Post Cap w/ Screws	C7F7C	--	\$3.00	\$3.00
325 Square Post Cap w/ Screws	C7K7C	--	\$3.00	\$3.00
325 Full Round Post Cap w/ Screws	C7K5C	--	\$3.00	\$3.00
325 Radius Post Cap w/ Screws	C7K2C	--	\$3.00	\$3.00
325 Extended Radius Post Cap w/ Screws	C7K4C	--	\$3.00	\$3.00
325/4000 Radius Corner Post Cap w/ Screws	C7K3C	--	\$3.00	\$3.00
325 Contour Post Cap w/ Screws	C7I9C	--	\$3.00	\$3.00
325 Corner Key, Standard	C583K1	--	\$1.50	\$1.50
325 Corner Key, Flush Face	C583K2	--	\$1.50	\$1.50
Stop Block w/ Screws	C51523004	4"	\$3.50	\$3.50
#10-24 x 1/2" FH Phillips SS Screw	C5816403	per 100	\$18.00	\$18.00
#10-24 x 3/4" FH Phillips SS Screw	C5816402	per 100	\$19.00	\$19.00

Series 750 Components

ref. page 03

Description	P/N	Stock Length	>\$3000	<\$3000
750 Standard Post	C7L0288	288"	\$270.00	\$303.00
750 Radius Post	C7L2288	288"	\$300.00	\$337.00
750 Standard Side Frame w/ Reveal	C6L00153	153"	\$120.00	\$135.00
750 Standard T/B Frame	C6L01219	219"	\$150.00	\$168.00
750 Flush Face Side Frame w/ Reveal	C6L10153	153"	\$133.00	\$150.00
750 Flush Face T/B Frame	C6L11219	219"	\$128.00	\$144.00
750 Radius Channel	C6L04219	219"	\$140.00	\$156.00
750 Standard Post Cap w/ Screws	C7L0C	--	\$6.00	\$6.00
750 Radius Post Cap w/ Screws	C7L2C	--	\$6.00	\$6.00
750/1200 Corner Key, Large	C583L4	--	\$5.00	\$5.00
750 Corner Key, Small	C583L3	--	\$3.00	\$3.00
Universal Raceway Cover	C51571219	219"	\$42.00	\$47.00
Stop Block w/ Screws	C51523004	4"	\$3.50	\$3.50
#10-24 x 3/4" FH Phillips SS Screw	C5816402	per 100	\$19.00	\$19.00

Charleston Manufacturing, LLC

PH: 1-800-647-2384 Fax: 1-800-413-0454

Series 1200 Components

ref. page 03

Description	P/N	Stock Length	>\$3000	<\$3000
1200 Econo Frame	C6M50218	294"	\$352.00	\$381.00
1200 Standard Base Frame	C6M51219	219"	\$194.00	\$210.00
1200 Retainer	C6M53219	219"	\$130.00	\$136.00
1200 Radius End (Male)	C7N2192	192"	\$265.00	\$280.00
1200 Radius End (Female)	C7N3192	192"	\$270.00	\$284.00
1200 Radius End Post Cap w/ Screws	C7N2C	--	\$10.00	\$10.00
750/1200 Corner Key, Large	C583L4	--	\$5.00	\$5.00
1200 Retainer Corner Key	C583M3	--	\$3.00	\$3.00
Universal Raceway Cover	C51571219	219"	\$43.00	\$47.00
#10-24 x 3/4" FH Phillips SS Screw	C5816402	per 100	\$19.00	\$19.00

Series 3000 & 4000 Components

ref. page 04

Description	P/N	Stock Length	>\$3000	<\$3000
3000 Triangular Post	C7P0240	240"	\$270.00	\$284.00
325/4000 Square Corner Post	C7K6288	288"	\$278.00	\$291.00
325/4000 Radius Corner Post	C7K3288	288"	\$255.00	\$268.00
3000 T/B Frame	C6P31240	240"	\$53.00	\$59.00
3000 Side Frame	C6P30240	240"	\$80.00	\$88.00
4000 T/B Frame	C6Q41240	240"	\$60.00	\$65.00
4000 Side Frame	C6Q40146	146"	\$94.00	\$103.00
Z-Bar	C51510240	240"	\$27.00	\$29.00
3000 Triangular Post Cap w/ Screws	C7P0C	--	\$3.00	\$3.00
325/4000 Square Corner Post Cap w/ Screws	C7F7C	--	\$3.00	\$3.00
325/4000 Radius Corner Post Cap w/ Screws	C7K3C	--	\$3.00	\$3.00

CWB Components

ref. page 04-05

Description	P/N	Stock Length	>\$3000	<\$3000
Dovetail Top	C51541153	153"	\$20.00	\$22.00
Dovetail Bottom w/ Screw Boss	C51545153	153"	\$31.00	\$34.00
Dovetail Bottom w/ Corner Key Slot	C51542153	153"	\$32.00	\$35.00
2" CWB	C51192020253	253"	\$94.00	\$102.00
3" CWB	C51142030252	252"	\$120.00	\$126.00
4" CWB	C51142040252	252"	\$180.00	\$189.00
5" CWB	C51142045253	253"	\$266.00	\$278.00
6" CWB	C51142046288	288"	\$222.00	\$232.00
8" CWB	C51142080288	288"	\$275.00	\$287.00
#10-24 x 1/2" FH Phillips SS Screw	C5816403	per 100	\$18.00	\$18.00
2" CWB Dovetail Assy. w/ Screws (Set of 2)	C51540002	1 3/4"	\$40.00	\$40.00
3" CWB Dovetail Assy. w/ Screws (Set of 2)	C51540003	2 3/4"	\$40.00	\$40.00
4" CWB Dovetail Assy. w/ Screws (Set of 2)	C51540004	3 3/4"	\$40.00	\$40.00

Charleston Manufacturing, LLC

PH: 1-800-647-2384 Fax: 1-800-413-0454

CWB Components

ref. pages 04-05

Description	P/N	Stock Length	>\$3000	<\$3000
5" CWB Dovetail Assy. w/ Screws (Set of 2)	C51540005	4 ³ / ₄ "	\$44.00	\$44.00
6" CWB Dovetail Assy. w/ Screws (Set of 2)	C51540006	5 ³ / ₄ "	\$44.00	\$44.00
8" CWB Dovetail Assy. w/ Screws (Set of 2)	C51540008	7 ³ / ₄ "	\$44.00	\$44.00
225 Corner Key, Flush Face	C583G2	--	\$1.50	\$1.50

Miscellaneous Extrusions & Components

ref. page 05-06

Description	P/N	Stock Length	>\$3000	<\$3000
Universal Raceway	C51570146	146"	\$59.00	\$59.00
Universal Raceway Cover	C51571219	219"	\$47.00	\$47.00
Stop Block / Post Filler	C51523153	153"	\$16.00	\$16.00
Post Connector	C51521153	153"	\$28.00	\$28.00
Center Mount Bracket	C51522146	146"	\$31.00	\$31.00
1/8" H-Bar	C51535153	153"	\$19.00	\$19.00
1/4" H-Bar	C51536153	153"	\$20.00	\$20.00
1/4" T-Bracket	C51531146	146"	\$28.00	\$28.00
5/8" Graphic Bar	C51550050	50"	\$7.00	\$7.00
1" Graphic Bar	C51551146	146"	\$6.00	\$6.00
2" Graphic Bar	C51552146	146"	\$11.00	\$11.00
4" Graphic Bar	C51554146	146"	\$17.00	\$17.00
5/8" x 5/8" U-Channel	C51560192	192"	\$19.00	\$19.00
Universal Flange Panel Adapter	C51515146	146"	\$47.00	\$47.00
125 U-Channel	C51561146	146"	\$15.00	\$15.00
1/16" T-Divider	C51529073	73"	\$23.00	\$23.00
1/8" T-Divider	C51533073	73"	\$35.00	\$35.00
1/16" J-Mullion	C51537073	73"	\$23.00	\$23.00
1/8" J-Mullion	C51538073	73"	\$26.00	\$26.00
Universal Dovetail	C51544146	146"	\$24.00	\$24.00
Base Mount Channel, Top	C51575218	218"	\$180.00	\$180.00
Base Mount Channel, Bottom	C51576218	218"	\$139.00	\$139.00
325/750 Post Support	C51525288	288"	\$222.00	\$222.00
#10-24 x 1/2" FH Phillips SS Screw	C5816403	per 100	\$18.00	\$18.00
#10-24 x 3/4" FH Phillips SS Screw	C5816402	per 100	\$19.00	\$19.00
3 1/4" Aluminum Pyramid Finial w/ Bolt	C58513	--	\$60.00	\$60.00
Ø2" Aluminum Round Finial w/ Bolt	C58511	--	\$60.00	\$60.00
Ø3" Aluminum Round Finial w/ Bolt	C58512	--	\$60.00	\$60.00
Ø4" Aluminum Round Finial w/ Bolt	C58514	--	\$60.00	\$60.00
Ø5" Aluminum Round Finial w/ Bolt	C58515	--	\$130.00	\$130.00

Warranty Information

Exclusive Warranty:

- This is the exclusive warranty of Charleston Manufacturing, LLC - Charleston MS, with respect to any and all of its products.
- Charleston Manufacturing, LLC warrants you as the original purchaser that our company's products will be free from defects in materials & workmanship, under normal conditions, upon shipment of said products from our facility.
- This exclusive warranty does not apply to damage caused by improper handling . Charleston Manufacturing, LLC shall have no liability or responsibility for any damage whatsoever caused by improper handling.
- Charleston Manufacturing, LLC disclaims any and all other warranties including, without limitation, implied warranties of merchantability and fitness for a particular purpose. The only warranty with respect to Charleston Manufacturing, LLC products is contained in this exclusive warranty. No oral or written representations shall extend Charleston Manufacturing, LLC exclusive warranty beyond the description herein.

WARRANTY PROCEDURES:

- The purchaser must notify Charleston Manufacturing, LLC in writing of any warranty claim prior to initiating any remedy upon the defective product. Upon receipt of such written notice, Charleston Manufacturing, LLC will direct that an authorized representative inspect the product and, if necessary, correct the defect in accordance with this exclusive warranty. Charleston Manufacturing, LLC will have the exclusive right to determine whether or not a defect is covered by this exclusive warranty.

REMEDIES:

- Provided that the warranty procedures are followed, Charleston Manufacturing, LLC will repair and/or replace the defective Charleston Manufacturing, LLC product(s) during the applicable warranty period without charge for parts or labor.
- Repair and/or replacement of defective Charleston Manufacturing, LLC product is the customer's exclusive remedy under our warranty.
- Charleston Manufacturing, LLC shall not be liable for any incidental or consequential damages if the Charleston Manufacturing, LLC product is defective or does not conform to this exclusive warranty. In any event , the maximum amount for which Charleston Manufacturing, LLC shall be liable to the purchaser shall be the original purchase price of the defective product.
- Any claim for breach of this exclusive warranty shall be brought, if at all, no later than (30) days from Charleston Manufacturing, LLC breach.

CUSTOMER SERVICE:

- Notice of a product defect covered by this exclusive warranty can be made in writing to:
Charleston Manufacturing, LLC
ATTN: Customer Service/Warranty Claim
122 Albert Buckley Drive
Charleston, MS 38921
fax: 800.413.0454